

Frame Tent Parts List

Tents by Ohenry Productions last a lifetime!

"CLASSIC" 40'X60' FRAME SKETCH

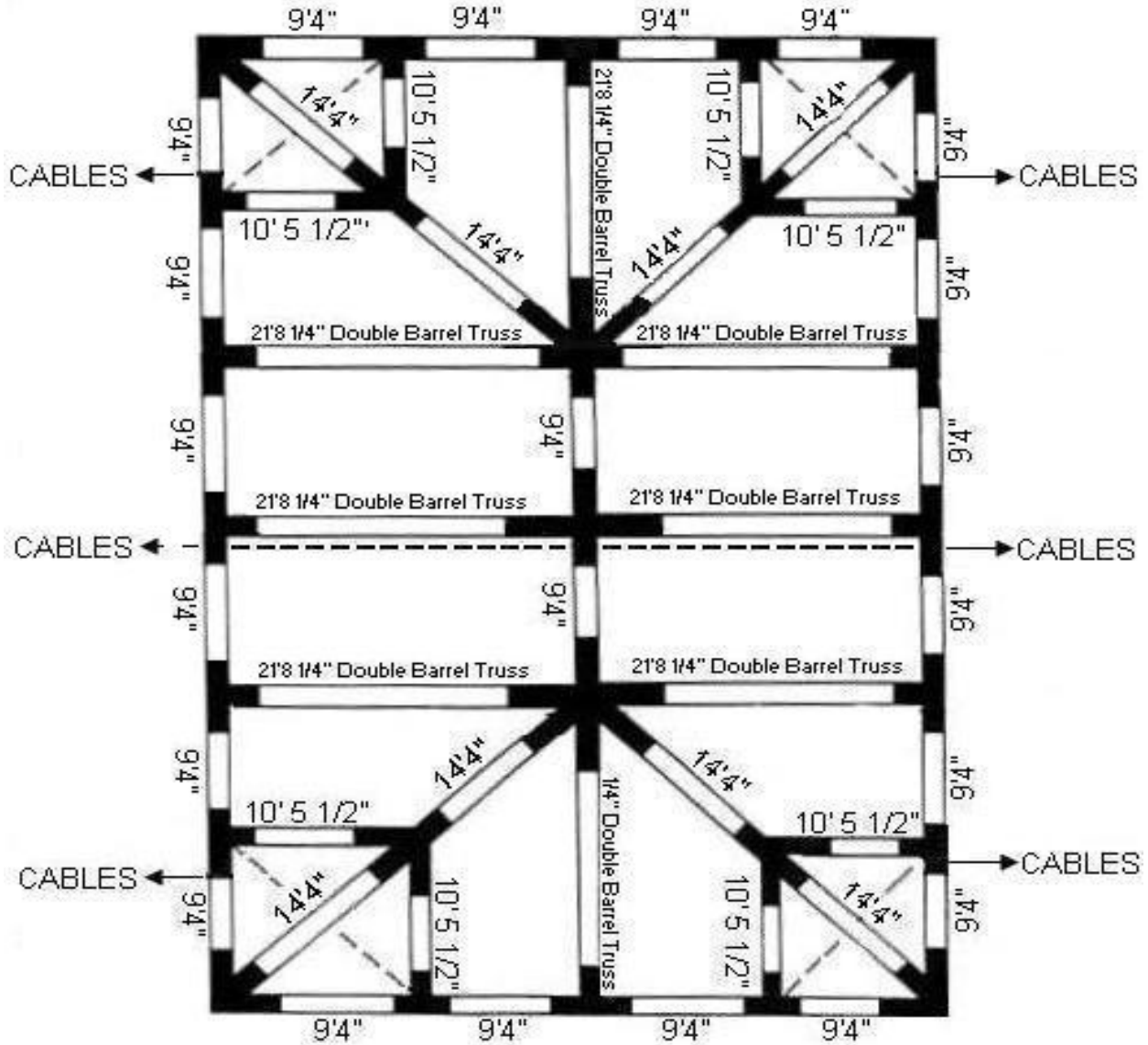

20	9'4" (112") X 2" SIDE BARS	4	STEEL CORNER FITTINGS
2	9'4" (112") X 2" TOP BARS	16	STEEL MID LEG/RAFTER FITTING
8	21'8 1/4" TRUSS MID RAFTER	1	4-WAY STEEL EXPANSION TOP FITTING
8	14' 4" (171") 2-PIECE CORNER RAFTERS	4	CORNER RAFTER Y FITTING (40' and over)
8	10' 5 1/2" (125 1/2") CORNER RAFTER SUPPORTS	2	6-WAY STEEL TOP FITTING CROWN
20	7' X 2" ADJUSTABLE LEG TOP	0	8-STEEL WAY TOP FITTING CROWN
20	5' X 1.75" LEG BASE	20	14' x 1/2" ROPES
4	13'8" CORNER CABLES	20	40" STEEL STAKES
1	CROSS CABLES FOR 40 WIDE 39'5"		

40' WIDE ASSEMBLY INSTRUCTIONS

SIX EASY STEPS

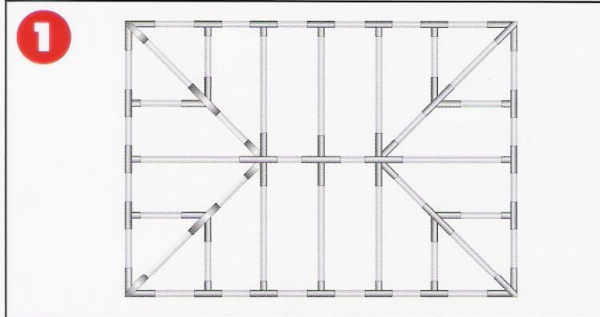

Lay out tubing on a flat surface based on the frame sketch provided.
(Example: 40' x 60')

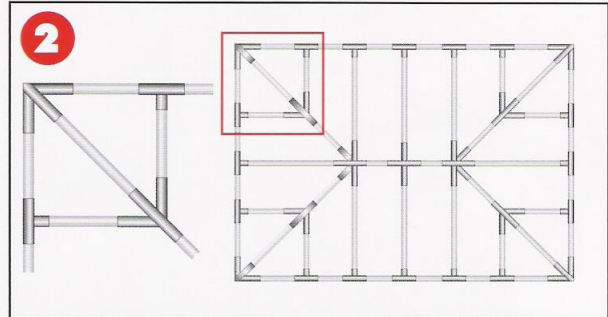

Make all four 1/2 corners to the Y-Fitting and then add corner cables.

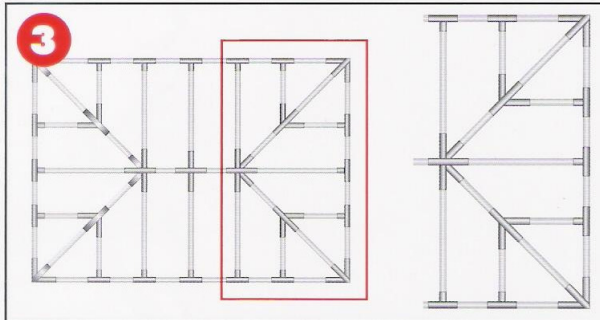

Complete both ends including Double Tube Trusses to the 6-way Top Fitting (8-Way Top Fitting on a 40' x 40'). When top portion of frame is complete and still on the ground, place cover on loosely over frame. If expandable, do the lacing once both ends are in place.

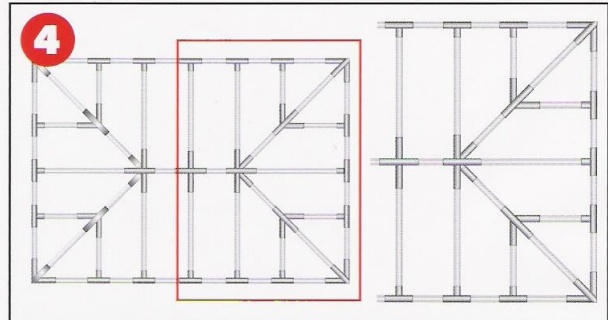

Add Mid Truss Double Tube and attach to the 4-Way Top Expansion Fitting. Then add Top Bar and connect to the 6-Way Crown. Continue until tent is complete.

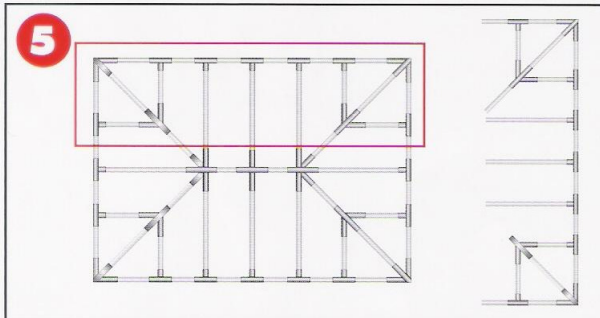

With the cover on the frame loosely, add legs on to the longer side and then do the same the opposite side. Last, put in the remainder of the legs.

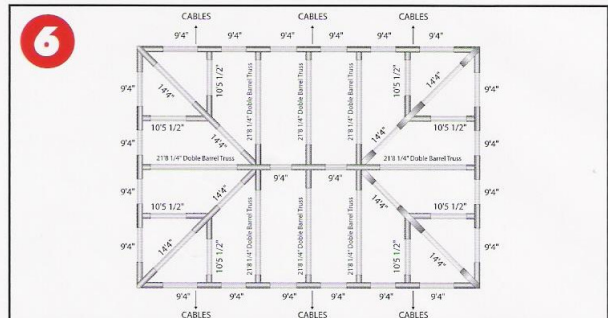

Finally, attach cross support cables across the center to the mid-leg rafter fitting. Then attach appropriate anchoring and secure cover tightly with straps & buckles.