

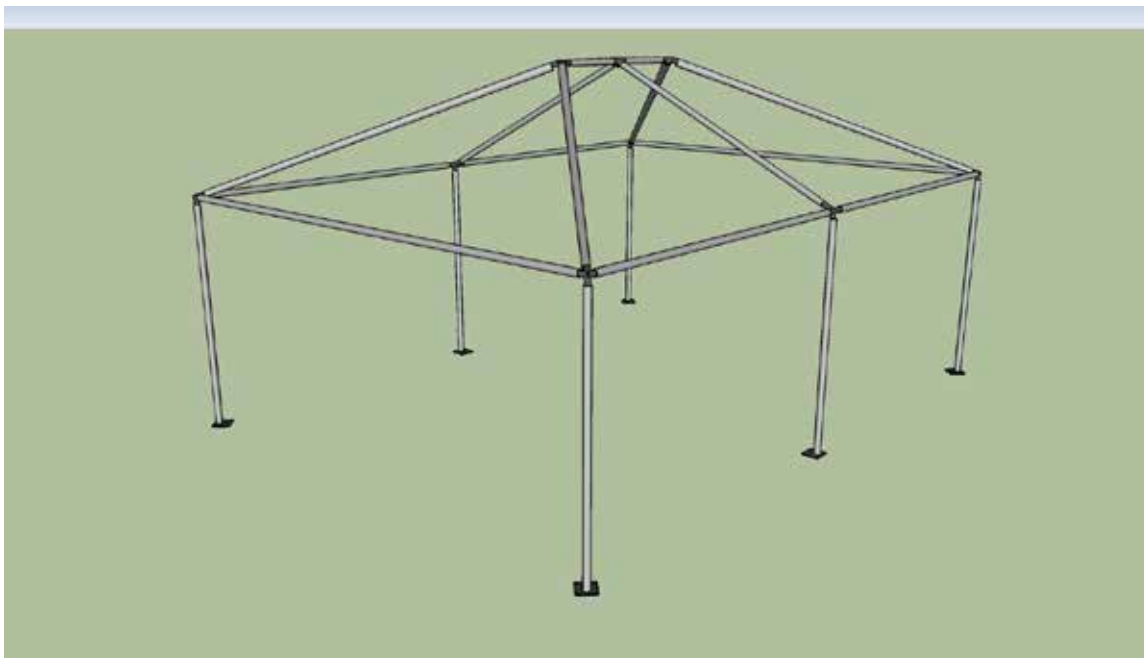

Ohenry 15'x20' Frame Tent



Ohenry Productions Inc. 3859 Chappel Hill Rd. Waco, TX. 76705
(254)714-1103 Office (254)714-1117 Fax



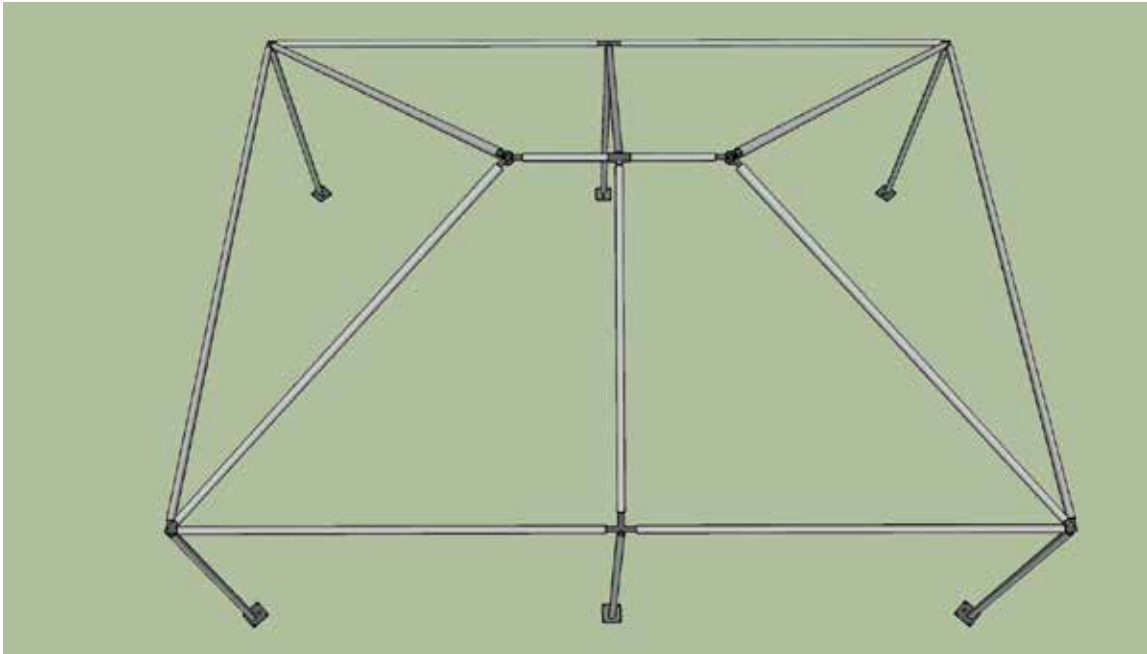



Ohenry 15'x20' Frame Tent



Ohenry Productions Inc. 3859 Chappel Hill Rd. Waco, TX. 76705
(254)714-1103 Office (254)714-1117 Fax

Fittings	
4	Corner Fitting
2	3 Way Crown
2	Side T Joint
1	Ridge Slide T
6	Base Plates
38	Canopy Pins

Poles		
2	14' 4"	Speaders
4	10' 6"	Hip Rafters
4	9' 4"	Spreaders
2	7' 8"	Rafters
6	6' 8"	Legs
1	4' 4"	Top Spreader

Part Identification	
 <p>3 Way Center Crown</p>	 <p>Base Plate</p>
 <p>Side T</p>	 <p>Ridge Slide T</p>
 <p>Corner Fitting</p>	 <p>Canopy Pin</p>

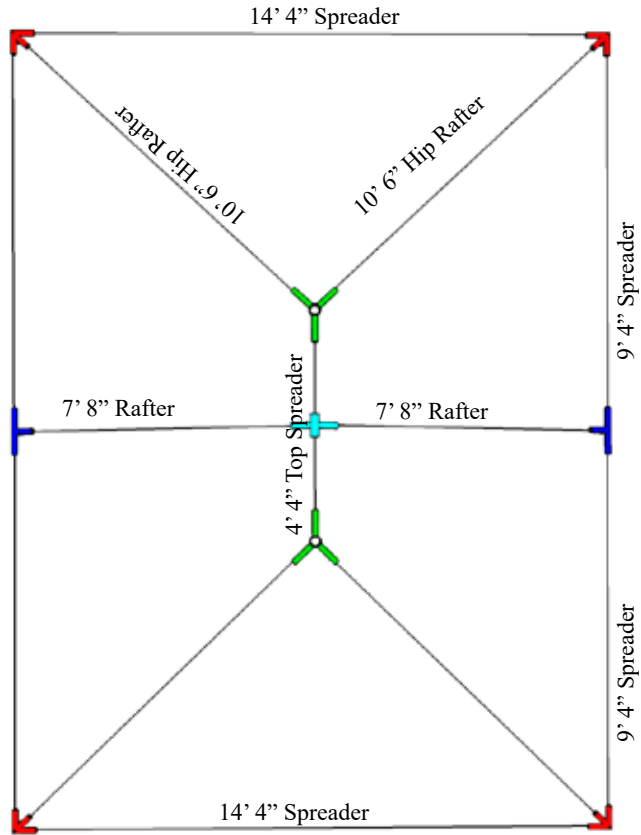

“OHENRY WEST COAST FRAME TENT” ASSEMBLY INSTUCTIONS
10' wide – 20' wide

All tubing is labeled for easy Identification.
Please verify the parts with the chart provided before you begin assembly.

Assembly Steps:

1. Lay out the Spreader pipes and Corner Fittings in a square or rectangle (refer to previous page). Lay out Hip Rafters and Rafters and Side T Joints. Place Center Crown(s) in the center of the tent.

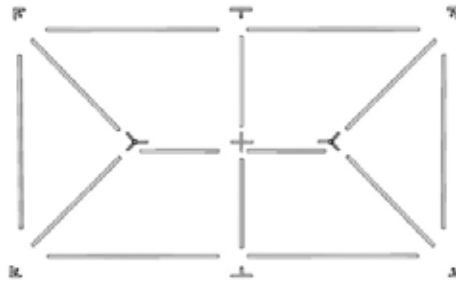

2. Start assembling the frame by inserting and pinning the Hip Rafters into the Center Crown(s). If assembling a rectangular frame insert and pin the appropriate Spreader into the Center Crown and continue to the next Ridge Top T or Center Crown. Insert and pin Rafters into the Crowns and Ridge Top T's. Insert and pin all Corner Fittings and Side T Joints to the bottom of the Hip Rafters and Rafters.



3. Start at one corner of the frame and insert and pin the Corner Fitting to the Spreader. Continue in one direction around the frame inserting and pinning each fitting to the Spreaders.



4. Unfold the tent cover on the ground next to the assembled frame. Place the cover on the frame. Be sure to center the cover while the upper structure is still on the ground.

(If you purchased a “Premium Style Top with curved valence, refer to last page before proceeding).
Use the buckles on the underside of the top to attach to the frame. Secure the two buckles closest to the corner first, then tighten the remainder of the buckles. Over-tightening the straps can cause unsightly wrinkling.



5. Lift one side of the tent and attach the legs (with base plates) and insert the pins. It is recommended that two people be available when lifting the frame to install legs.

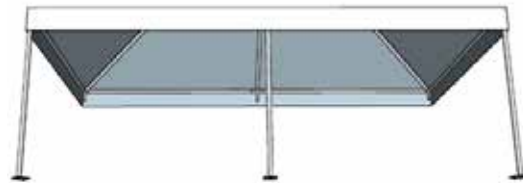

6. Lift the other side of the tent and attach the legs (with base plates). While this unit will stand on its own, it is NOT intended that the base plates be used as an anchoring method. The stakes should be driven approximately 5 feet away from the bottom of the leg. It is imperative the tent be secured with ropes and stakes or any other appropriate anchoring method. It is recommended that you do not bolt the base plates to any surface. Store the cover only when clean and dry.

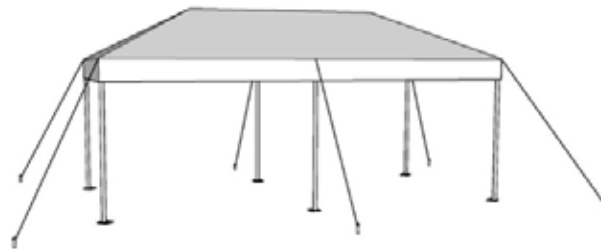

In the event of high winds, the cover should be removed from the frame to prevent damage to your tent. Your tent should be vacated during inclement weather.

OHenry “Premium” Tent Top Additional Instructions



If you purchased an OHenry “premium” Top which has the curved valance, after completing step # 4 in the assembly instructions, you will attach the end of the ratchet strap which has the metal clip (ratchets are included with your tent top) to the rings in the tent top at the corners and depending on size, the other locations on the tent top perimeter which have rings attached. Now insert the bases into two legs and then insert the poles into the first two corners of the tent frame. Next attach the other end of each ratchet which has a ring attached to the base as shown in the photograph below. Tighten ratchet enough to have a slight tension. Do the same for each leg you insert into frame in next steps. Proceed to step #5 above. After inseting all legs, and raising tent frame with top attached, tighten all the ratchets connecting the tent top to the leg bases.

