

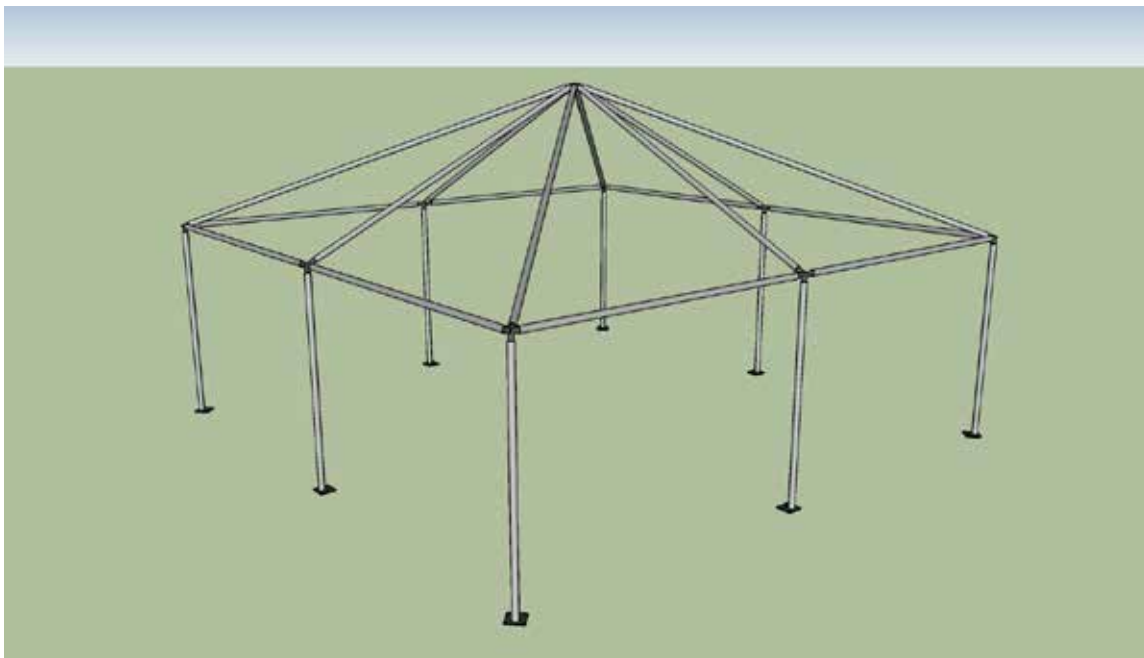

Ohenry 20'x20' Frame Tent



Ohenry Productions Inc. 3859 Chappel Hill Rd. Waco, TX. 76705
(254)714-1103 Office (254)714-1117 Fax



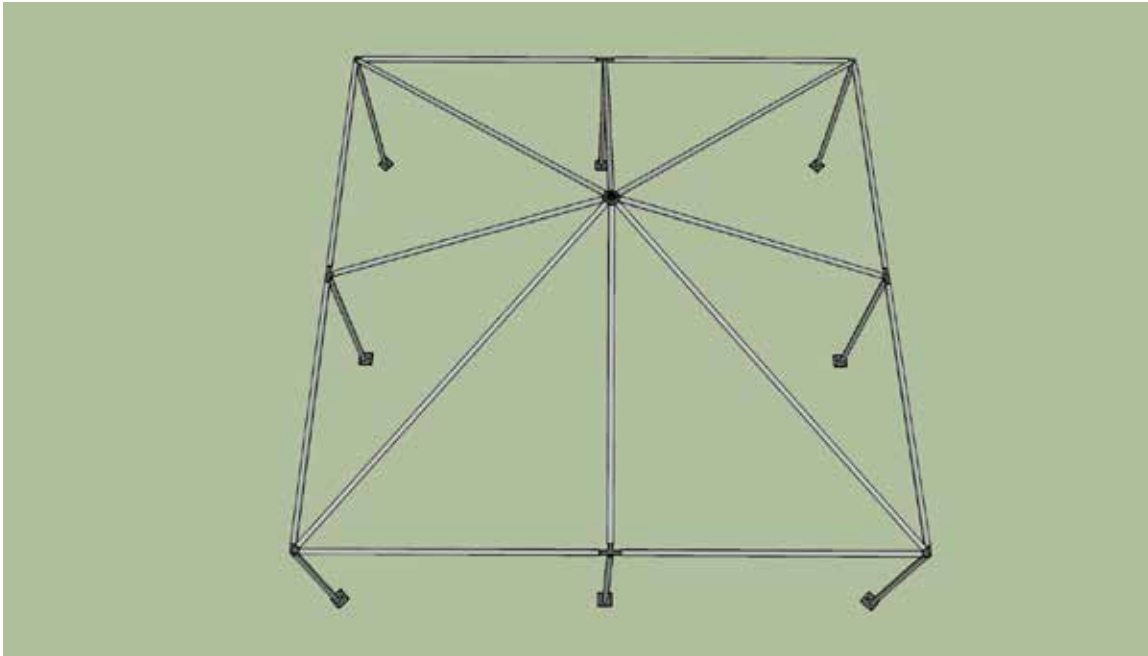
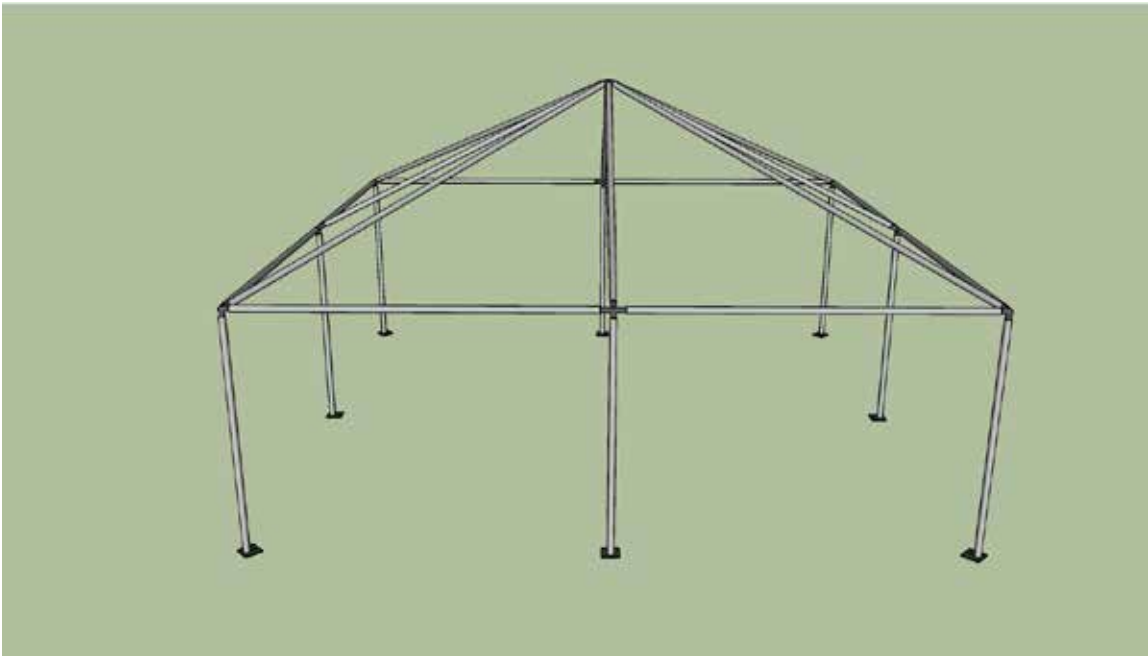

Ohenry 20'x20' Frame Tent



Ohenry Productions Inc. 3859 Chappel Hill Rd. Waco, TX. 76705
(254)714-1103 Office (254)714-1117 Fax

Fittings	
4	Corner Fitting
1	8 Way Crown
4	Side T Joint
8	Base Plates
48	Canopy Pins

Poles		
4	14' 4"	Hip Rafters
4	10' 6"	Rafters
8	9' 4"	Spreaders
8	6' 8"	Legs

Part Identification	
 <p>8 Way Center Crown</p>	 <p>Base Plate</p>
 <p>Side T</p>	 <p>Canopy Pin</p>
 <p>Corner Fitting</p>	

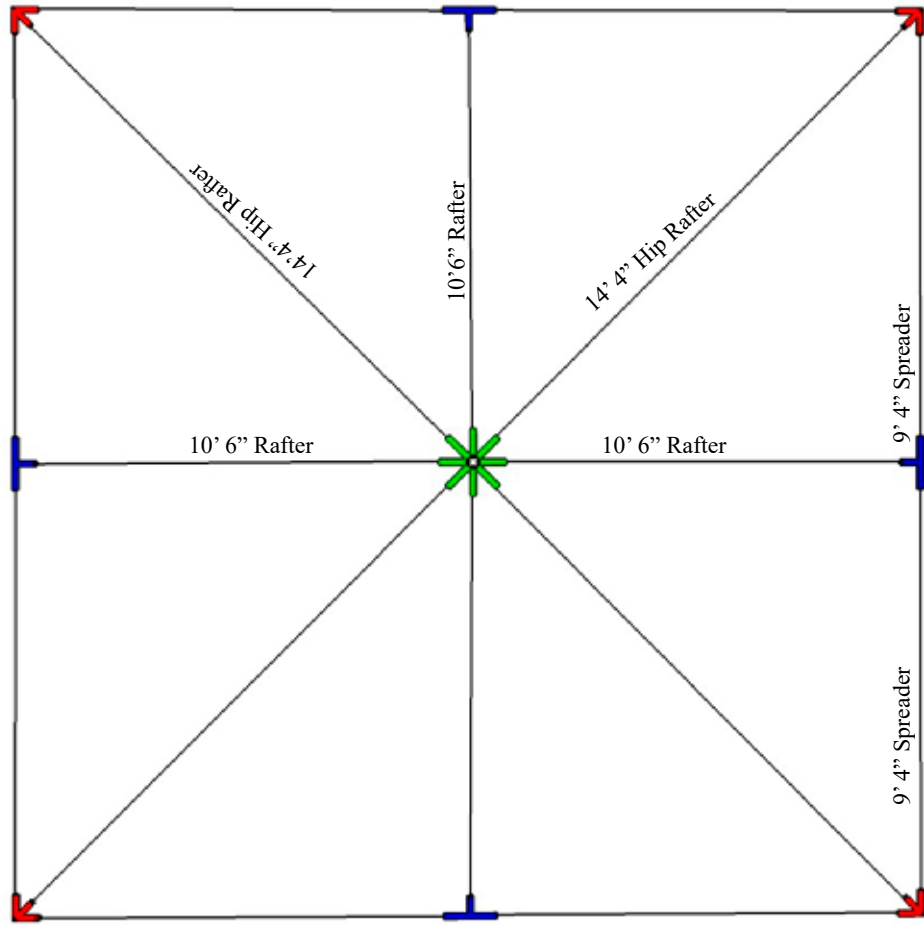

“OHENRY WEST COAST FRAME TENT”

ASSEMBLY INSTRUCTIONS

All tubing is labeled for easy Identification.

Please verify the parts with the chart provided before you begin assembly.

Assembly Steps:

1. Place the Side bars in a square on a flat surface
 2. Place one Corner fitting in each corner
 3. For tents over 15' place the Mid-Leg/Rafter fittings between Side bars at 10' intervals
 4. Slide the Side bars into the Corner fittings until the holes in the fitting and tubing match up and insert pin. Then attach the Side bars to the Mid-Leg/Rafter fittings. Be sure that the pins in place. The perimeter of your unit is now assembled
 5. Slide a Corner rafter into each Corner fitting until the holes in the fitting and tubing match up and insert pin.
 6. Install the Top fitting on the Corner rafter in opposite pairs (Important: Be sure the slightly shorter fitting stubs are pointed towards the corners. The slightly longer stub on the Top fitting align with the Mid-Leg/Rafter fittings.)
 7. For tents over 15' slide a Mid Rafter into the Top fitting first then into the corresponding MidLeg/Rafter fitting. The perimeter of the frame is designed to flex sufficiently to make this step easy. Repeat this step for each remaining Mid-Rafter. Remember to work in opposite pairs. The upper structure is now complete
 8. Place the cover on the frame. Be sure to center the cover while the upper structure is still on the ground. If you purchased a “Premium Style Top with curved valence, refer to last page before proceeding)
 9. Lift one side of the tent and attach two legs (with base plates). Repeat for the other side. The attach (if applicable) the remaining legs in each Mid-Leg/Rafter. (It is recommended that two persons be available when lifting the frame to install legs.)
 10. Before raising the legs, secure the cover using the snap buckles. Start by securing one corner and then the opposite corner. Once the corners are secure, tighten the snap buckles by the Mid-Leg/Rafter fittings. The rest of the snap buckles should be tightened until the cover is firmly and evenly attached to the frame. Over-tightening the straps can cause unsightly wrinkling.
 11. Raise the frame height until the holes in the fitting and tubing match up and insert pin.
 12. While this unit will stand on its own, it is NOT intended that the base plates be used as an anchoring method.
- It is imperative the tent be secured with ropes and stakes or any other appropriate anchoring method. It is recommended that you do not bolt the base plates to any surface. Store the cover only when clean and dry. In the event of high winds, the cover should be removed from the frame.

OHenry “Premium” Tent Top Additional Instructions



If you purchased an OHenry “premium” Top which has the curved valance, after completing step # 8 in the assembly instructions, you will attach the end of the ratchet strap which has the metal clip (ratchets are included with your tent top) to the rings in the tent top at the corners and depending on size, the other locations on the tent top perimeter which have rings attached. Now insert the bases into two legs and then insert the poles into the first two corners of the tent frame. Next attach the other end of each ratchet which has a ring attached to the base as shown in the photograph below. Tighten ratchet enough to have a slight tension. Do the same for each leg you insert into frame in next steps. Proceed to step #9 above. Step # 10 does not apply to the OHenry “Premium” frame tents. After inseting all legs, and raising tent frame with top attached, tighten all the ratchets connecting the tent top to the leg bases.

